



# LC-WELD PRO

**WELD. CLEAN. MARK.**



**Global presence**

**Own manufacturing and  
original design**

At LC we work to offer the best laser solutions in the world of welding, industrial cleaning and product marking and engraving.





### **Analysis**

Day by day we work to give our clients the best service. We want that every laser equipment is the most suitable for every case. LC is committed to offer the best option in the laser technology world, we will advise you so you can make the perfect decision. We offer 100% personalized solutions to each client.



### **Production**

LC produces laser equipment in our facilities, to provide a faster, more efficient and higher quality service. Thanks to our production system we can ensure every detail is perfect and our machines are ready to work.



### **Quality**

Our components are top from brands so that your laser equipment works 100% from the first moment. We work with a rigorous system to improve controls and ensure the best performance of the equipment.



### **After-sales service**

We offer a comprehensive 2.0 after-sales service, with phone attention, mail and videocall assistance. We have qualified technicians who provide training online and face-to-face, in addition to offering a technical service thoroughfull and fast. We aim to offer the fastest and effective solution as possible aim.

# Index

|                             |       |
|-----------------------------|-------|
| • Laser type and technology | p. 5  |
| • LC-WELD PRO equipment     | p. 6  |
| • Software                  | p. 8  |
| • Feeder                    | p. 10 |
| • Gun                       | p. 11 |
| • Materials & Applications  | p. 12 |
| • Security                  | p. 13 |
| • Process comparison        | p. 14 |
| • Technical information     | p. 15 |



# Laser Type and Technology

---

## 1 Speed and precision

Laser technology is very versatile, it can be applied in cutting and engraving, laser marking, even in cleaning. Laser welding is increasingly present in different sectors and can be used in metal surfaces, stainless steel or other welding processes in industries. It can replace traditional arc welding, stainless steel plate, iron plate, aluminium plate and the welding of other materials.

## 2 Minimal deformation

The laser welding machine has a high quality fibre laser and is designed to be easy and comfortable to use, it has an integrated interactive control system that can vary the finish, depth and width of the weld, according to the work to be done depending on the surface.

## 3 Easy to use, no experience required

LC WELD PRO is the improved version of the latest generation of LC laser welding equipment. It is a device with new functionalities and is much more user-friendly.

The laser welding equipment has a gun designed exclusively by LC, a new 40% more efficient laser generator and a new software system designed specifically for laser welding.

The programme allows us to work with user control at different levels, it has 3 work functionalities to adapt to each user, a technical help system in the same equipment and the possibility of controlling welding costs and obtaining statistics. The equipment can work with

or without material input. Fibre laser welding can be used on surfaces such as stainless steel sheets, carbon steel or galvanised sheets, thus allowing the arc welding system to be replaced.

In addition, laser welding can be used at high speeds, with very fast welds. The deformation in this type of welding is minimal, with a very focused and reduced heat input on the material. Laser welding does not require high skilled labor. Other advantages of laser welding are: low fume generation, the possibility of working on very small and detailed seams, eliminating the need for later polishing and minimal heat input.

# LC-WELD PRO equipment

Our laser welding equipment is convenient, easy to use and offers great versatility.



## Removable feeder

Rotation system included.

## Touch screen 10"

A single touch screen to control the wire feeder and laser equipment.

## Easy connect

Easily connected to the cabin, internet connection system and system update.

## Laser Quality

Laser with an efficiency of 42% and high beam quality.

## NEW LC-GUN V4

- Built-in driver.
- Unique on the market.
- Designed and manufactured by LC.

## Interchangeable nozzle

Possibility of varying the laser nozzles for all types of work and also performing LASER CLEANING.

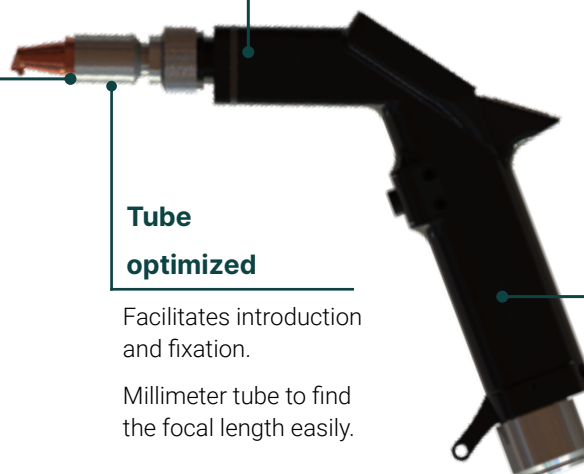

## Tube optimized

Facilitates introduction and fixation.

Millimeter tube to find the focal length easily.

## The lightest

300 gr. less than the old model



# General characteristics

---

## Synergistic parameters

Work easily by entering the type of sheet, thickness and material.

## Easy to use

This laser machine does not require a great deal of experience on from the worker as is the case with traditional welding equipment.

## Thread contribution

Removable winder without the need for an external system. Improvement in the quality of the take-up.

## Clean welding

Fast, consumable-free, clean and discolouration-free welding.

## Precision

Laser welding makes it possible to work on very small and detailed seams.

## Cooling

German-made radiator with its own design.

## Convenience

Lightweight design, comfortable and easy to move and operate, for more comfortable working.

## Speed

They have a welding speed of 0-60mm/s.

## Incorporates laser cleaning

Allows laser cleaning of welds using the same equipment.

## Great depth

The different LC models can reach up to 5mm welding depth.

## Great versatility

The same machine can be used for many types of work, depends on the parameters applied.



# Software

## Work: Basic, Advanced & Jobs

Three working options:

- **BASIC:** Work from pre-configured parameters.
- **ADVANCED:** the user can work with total freedom and parameterisation, and configure 'work profiles' to preconfigure the BASIC parameters.
- **JOBS:** Work from previously established pending tasks and jobs to be carried out.

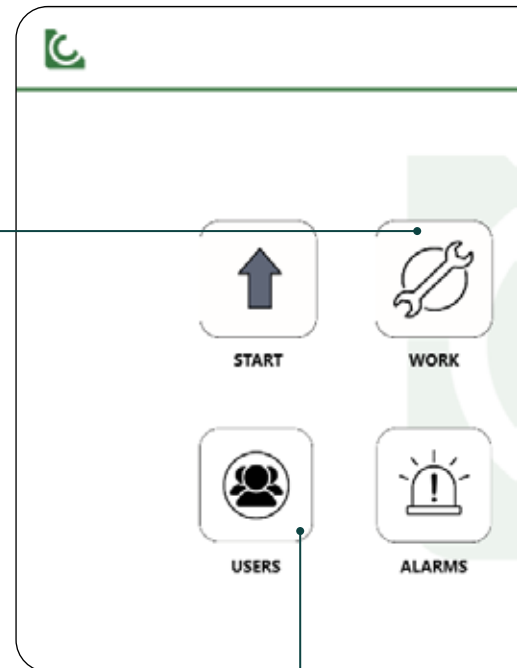
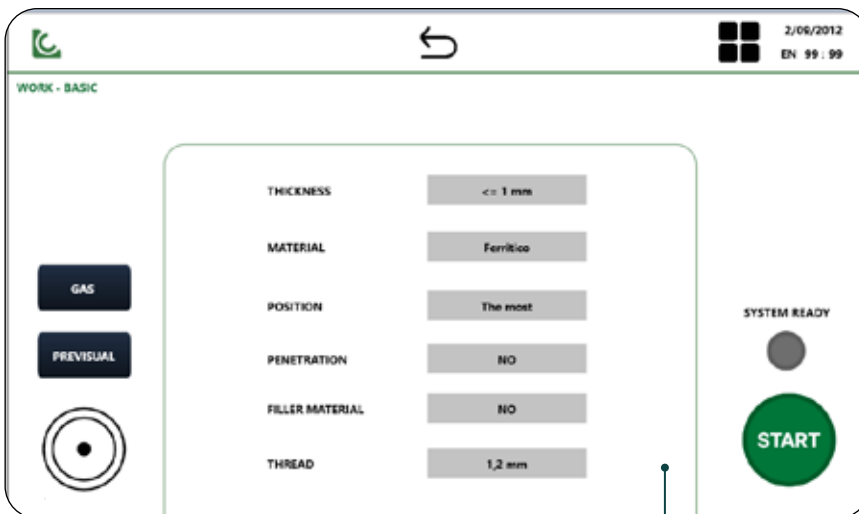

## Users control

User access control. Creation of groups to assign jobs. Establish user levels for different permissions.

## Welding screen

EPIS reminder, laser status indicators and feeder control.

Indicator light when the laser is operating.

## Synergistic parameters





Integrated software designed and programmed by LC. Intuitive and easy to use, with different functionalities. Software that allows remote technical assistance, different work modes, job scheduling and user control at different levels.

Depending on the user's permissions, the operator will have access to some functionalities or others.

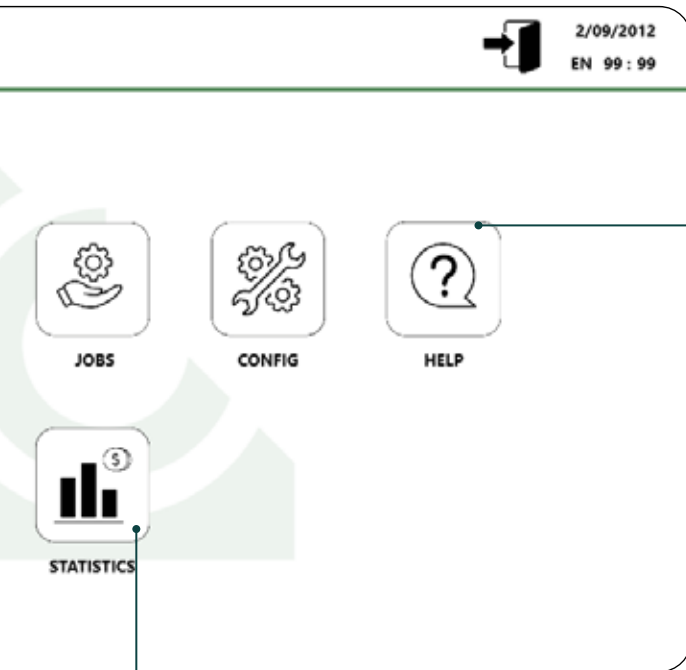

### Video and documentation on the same equipment

Direct access on the same computer to:

- Videos for questions and doubts
- Documentation (manual, CE, warranty)



### Cost control and statistics visualisation

Control of costs divided by jobs or general team.

Calculate the cost of cleaning and the cost per meter of welding.

| TIME        |                 | COSTS            |               |
|-------------|-----------------|------------------|---------------|
| TOTAL TIME  | -00000000.0 s   | ELECTRIC         | -00000000.0 € |
| WORK TIME   | -00000000.0 %   | APORTE           | -00000000.0 € |
| PAUSE TIME  | -00000000.0 %   | LABOUR FORCE     | -00000000.0 € |
| WELD TIME   | -00000000.0 %   | GAS              | -00000000.0 € |
| APORTE      |                 | TOTAL COST       | -00000000.0 € |
| WELD APORTE | -00000000.0 %   | COST PR. PIECE   | -00000000.0 € |
| METERS WELD | -00000000.0 m   | COST PR. METER   | -00000000.0 € |
| CONSUMPTION |                 | PIECES           |               |
| GAS         | -00000000.0 L   | NUMBER OF PIECES | -00000000     |
| ELECTRIC    | -00000000.0 kWh | AVERAGE TIME     | -00000000.0 s |

# Feeder

Winding machine designed to work at low speeds, improved laser welding performance.

**Removable wire feeder without the need of an external system**

**Improved wire feed quality**



**Encoder motor made in Italy**



**Special sheaves for aluminum**



# Laser welding gun - LC-WELD GUN SM V 4.2

LC-WELD PRO presents a new gun with a renewed design and original.



## New tube system

Easy introduction and collocation.  
Pressure fastening and subsequent thread.  
Millimeter tube to find the focal length easily along with new help software.  
\*We have added innovative software to determine focal length uniformly across all clients.

## Focal length improvement

The focal length does not change with the change of nozzle.  
New Software\*

## 2 lens protectors, focal lens and collimator lens in easy-removal drawers

Easy maintenance and change of lenses

## New S.M. technology

Directional mirror system replaces the galvanometric system.  
Interior plans impossible.

## Improves gear factor in aluminum (Between 2 and 3 times higher)

## Incorporates laser cleaning option

## Better ergonomics

Lower weight and more manageable system.

## Driver included in the gun

Eliminates interference problems.

Change tool built-in lenses

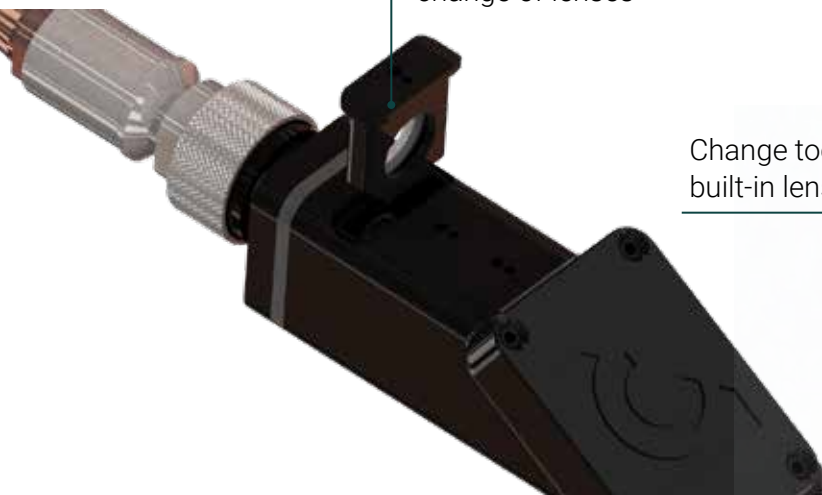

# Materials and applications

## Material tables

|                  | WELDING |
|------------------|---------|
| Stainless steel  | ✓       |
| Galvanised steel | ✓       |
| Aluminium        | ✓       |
| Titanium         | ✓       |
| Carbon steel     | ✓       |
| Special alloys   | ✓       |

1  
Minimal  
deformation

2  
Elimination of  
the reworking  
process

3  
More penetration

## Applications and Industry

Laser welding allows to reduce the affected thermal zone at the moment of working, being able to use different joining and welding techniques.

Laser welding machinery is highly versatile, especially due to its wide range of penetration and laser power. Different applications of laser welding equipment can be highlighted: electronics, automotive parts, veneering, metal furniture, some parts of household appliances, tubes and pipes, metal tools, containers for different industries, food industry (machinery, packaging or cutting blades), pharmaceutical industry, titanium and aluminium parts...

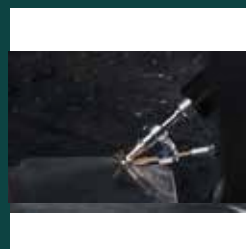

# Laser security

---

LC has the necessary PPE to work with the LC-WELD PRO equipment.

## Safety glasses

Mandatory for working with lasers, DLB 6 protection.

Note: Make sure your goggles provide protection for the laser beam and wavelength of your laser equipment. Consult an expert.



## Welding mask

Necessary protection from UV light generated by the welding process.



## Cabin

Adaptable according to the customer's needs, if necessary. LC-CABIN is a modular cabin to establish a controlled laser working area, in case the customer does not have one by his own means.



**WE CARE ABOUT YOU.**

# Process comparison

## TIG

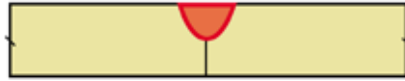

## LASER

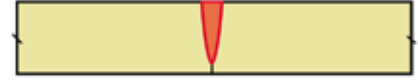

### PENETRATION

1.0-1.5mm

Up to 5mm

### SPEED

Slow welds

Very fast welds

### DISTORSION

High deformation

Minimal deformation

### ABILITY

Soldador con alta habilidad

No great experience required

# Joint configurations

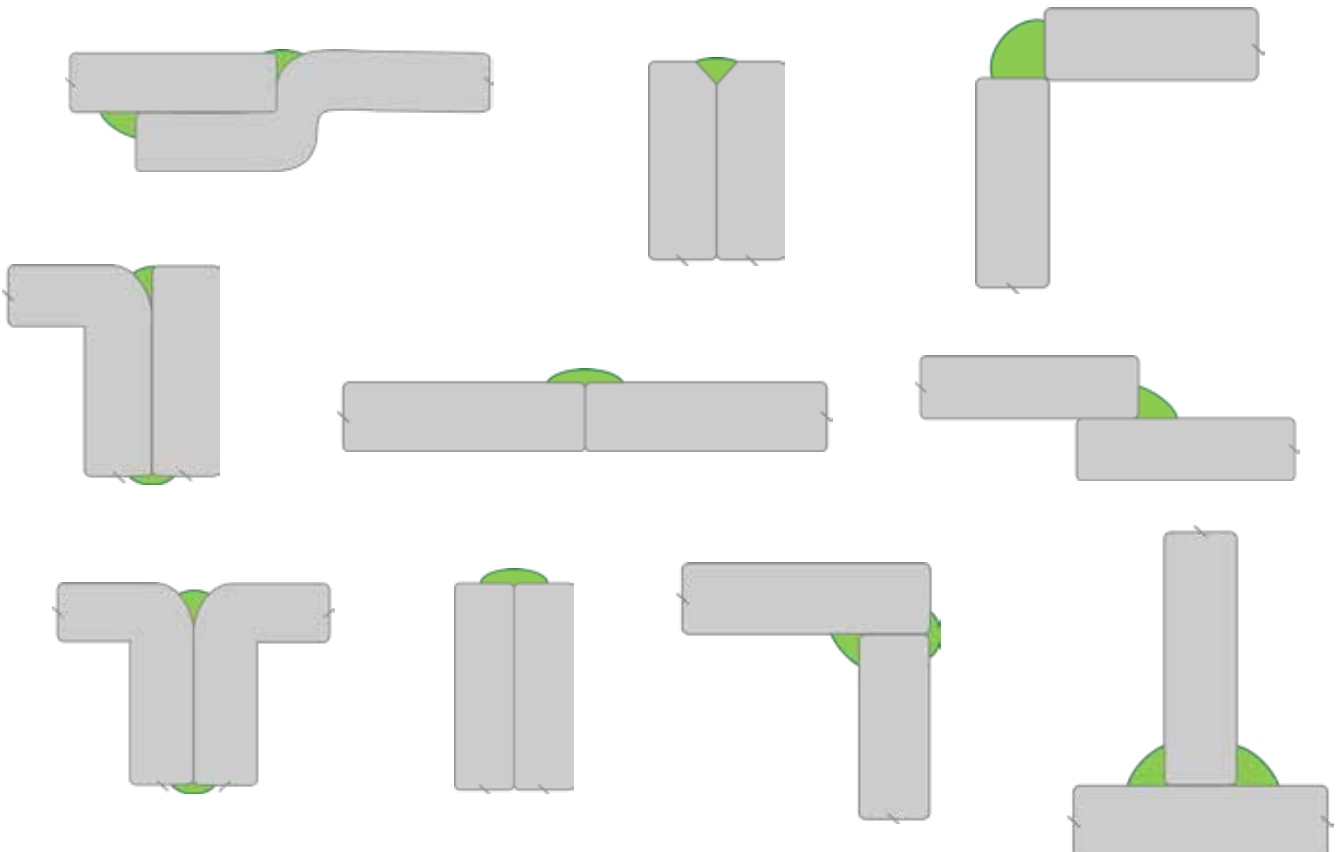

# Technical information

|                                   | <b>LC WELD PRO</b> |
|-----------------------------------|--------------------|
| <b>Model</b>                      | LC-WELD PRO        |
| <b>Laser power</b>                | 1500w              |
| <b>Power consumption</b>          | <5500W             |
| <b>Power supply voltage</b>       | 220-240VAC         |
| <b>Wavelength</b>                 | 1070nm ±10         |
| <b>Frequency range</b>            | <50 kHz            |
| <b>Power stability (2 hours)</b>  | <1,5%              |
| <b>Power stability (24 hours)</b> | <2%                |
| <b>Laser efficiency</b>           | 42%                |
| <b>Laser class</b>                | 4 (IEC 60825-1)    |
| <b>Weight</b>                     | <150kg             |
| <b>Hose length Approx.</b>        | 8m                 |
| <b>Approx. dimensions</b>         | 420x720x1100 mm    |

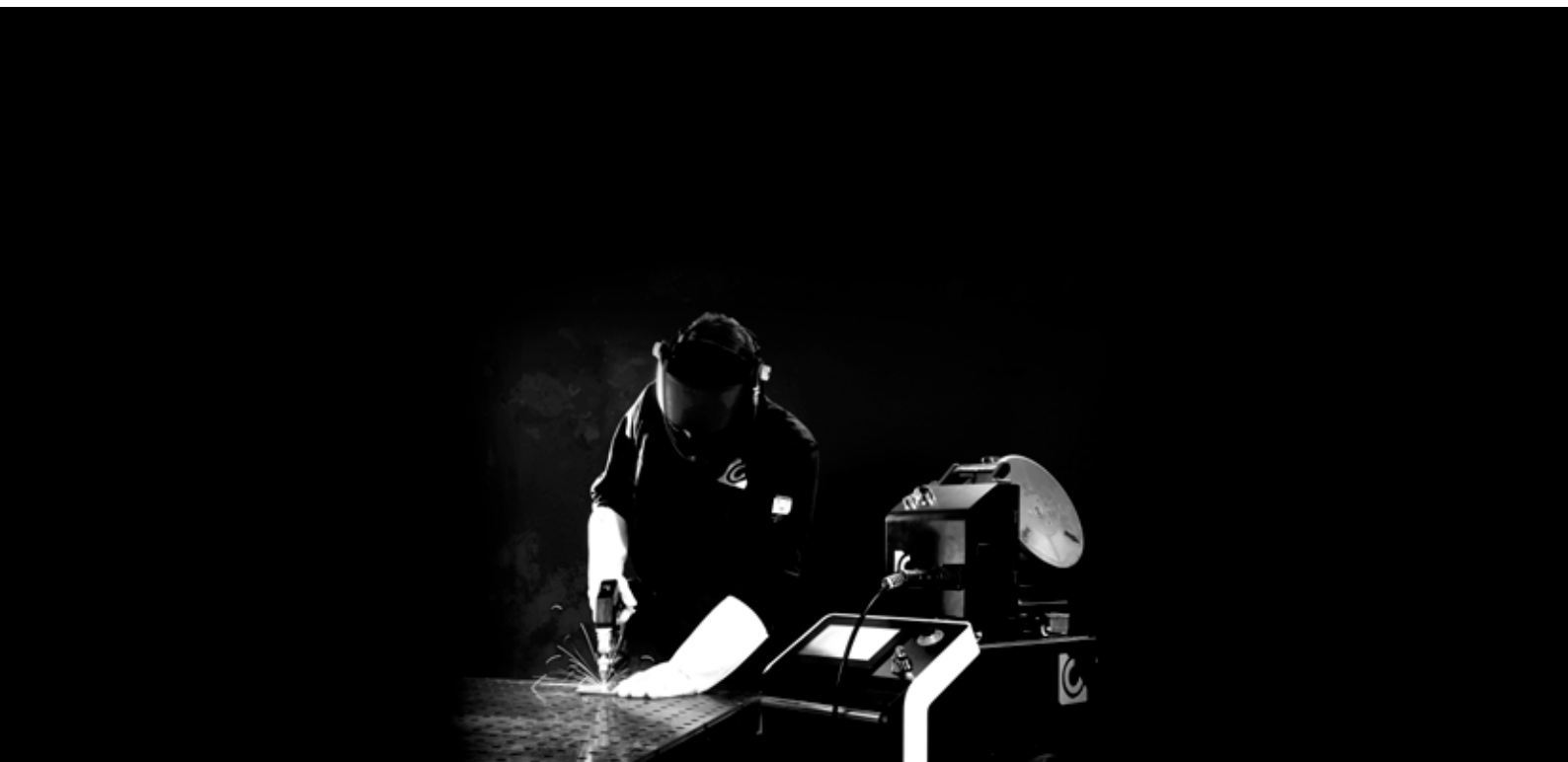





C/ Pere Andorrà, 5, Nave 6  
08650 · Sallent  
Barcelona (Spain)

M. +34 623 337 600  
T. +34 936 281 426

[contacto@lclasers.com](mailto:contacto@lclasers.com)



[www.lclasers.com](http://www.lclasers.com)

02.11.01\_EN\_004