



LC-WELD SMART

WELD. CLEAN. MARK.



Global presence

**Own manufacturing and
original design**

At LC we work to offer the best laser solutions in the world of welding, industrial cleaning and product marking and engraving.





Analysis

Day by day we work to give our clients the best service. We want that every laser equipment is the most suitable for every case. LC is committed to offer the best option in the laser technology world, we will advise you so you can make the perfect decision. We offer 100% personalized solutions to each client.



Production

LC produces laser equipment in our facilities, to provide a faster, more efficient and higher quality service. Thanks to our production system we can ensure every detail is perfect and our machines are ready to work.



Quality

Our components are top from brands so that your laser equipment works 100% from the first moment. We work with a rigorous system to improve controls and ensure the best performance of the equipment.



After-sales service

We offer a comprehensive 2.0 after-sales service, with phone attention, mail and videocall assistance. We have qualified technicians who provide training online and face-to-face, in addition to offering a technical service thoroughfull and fast. We aim to offer the fastest and effective solution as possible aim.

Index

• Laser type and technology	p. 5
• LC-WELD PRO equipment	p. 6
• Software	p. 8
• Feeder	p. 10
• Gun	p. 11
• Materials & Applications	p. 12
• Security	p. 13
• Process comparison	p. 14
• Technical information	p.14



Laser Type and Technology

1 Speed and precision

Laser technology is very versatile, it can be applied in cutting and engraving, laser marking, even in cleaning. Laser welding is increasingly present in different sectors and can be used in metal surfaces, stainless steel or other welding processes in industries. It can replace traditional arc welding, stainless steel plate, iron plate, aluminium plate and the welding of other materials.

2 Minimal deformation

The laser welding machine has a high quality fibre laser and is designed to be easy and comfortable to use, it has an integrated interactive control system that can vary the finish, depth and width of the weld, according to the work to be done depending on the surface.

3 Easy to use, no experience required

LC-WELD SMART is the reduced version of our laser welding products with very simple and intuitive software. Part of the LC-WELD range, it has fewer features but the same quality as other equipment. An air cooling system allows us to achieve a small and light equipment. LC-WELD SMART features the same original, LC-designed gun as the PRO model.

The laser welding equipment has a gun designed exclusively by LC, a new 40% more efficient laser generator and a new software system designed specifically for laser welding.

The programme allows us to work with user control at different levels, it has 3 work functionalities to adapt to each user, a technical help system in the same equipment and the possibility

of controlling welding costs and obtaining statistics. The equipment can work with or without material input. Fibre laser welding can be used on surfaces such as stainless steel sheets, carbon steel or galvanised sheets, thus allowing the arc welding system to be replaced.

In addition, laser welding can be used at high speeds, with very fast welds. The deformation in this type of welding is minimal, with a very focused and reduced heat input on the material. Laser welding does not require high skilled labor. Other advantages of laser welding are: low fume generation, the possibility of working on very small and detailed seams, eliminating the need for later polishing and minimal heat input.

Improved drag quality

Removable feeder without the need of an external system

Electronic board manufactured by LC

Motor with Encoder and made in Italy



Removable feeder

7" screen

Simple control of simple and intuitive software.

Electronics by LC

All developed by LC with its own firmware.

Laser with 40% efficiency

Highly efficient laser.



**NEW
LC-GUN V4**

- Built-in driver.
- 2 axes.
- SM technology
- Original LC design.

Interchangeable tip

Possibility of varying the laser nozzles for all types of work and also of carrying out LASER CLEANING

New piping system

Facilitates insertion and fixation. Millimeter tube to easily find the focal length.

The brightest

300g. less than the previous model

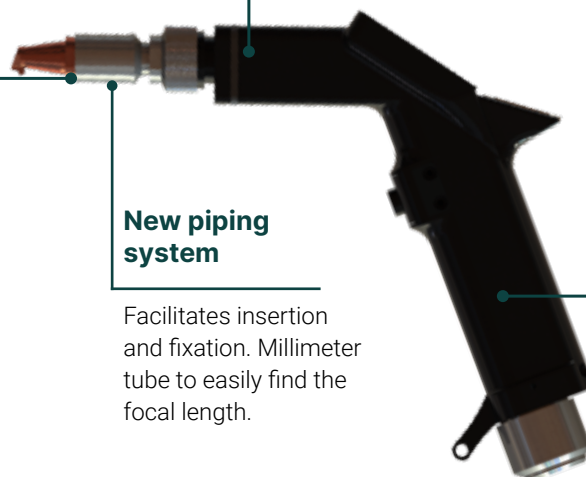

General characteristics

Synergistic parameters

Work easily by entering the type of sheet, thickness and material.

Easy to use

This laser machine does not require a great deal of experience on from the worker as is the case with traditional welding equipment.

Thread contribution

Removable winder without the need for an external system. Improvement in the quality of the take-up.

Clean welding

Fast, consumable-free, clean and discolouration-free welding.

Precision

Laser welding makes it possible to work on very small and detailed seams.

Cooling

German-made radiator with its own design.

Convenience

Lightweight design, comfortable and easy to move and operate, for more comfortable working.

Speed

They have a welding speed of 0-60mm/s.

Incorporates laser cleaning

Allows laser cleaning of welds using the same equipment.

Great depth

The different LC models can reach up to 5mm welding depth.

Great versatility

The same machine can be used for many types of work, depends on the parameters applied.



Software

Work: Basic, Advanced & Jobs

Three working options:

- **BASIC:** Work from pre-configured parameters.
- **ADVANCED:** the user can work with total freedom and parameterisation, and configure 'work profiles' to preconfigure the BASIC parameters.
- **JOBS:** Work from previously established pending tasks and jobs to be carried out.

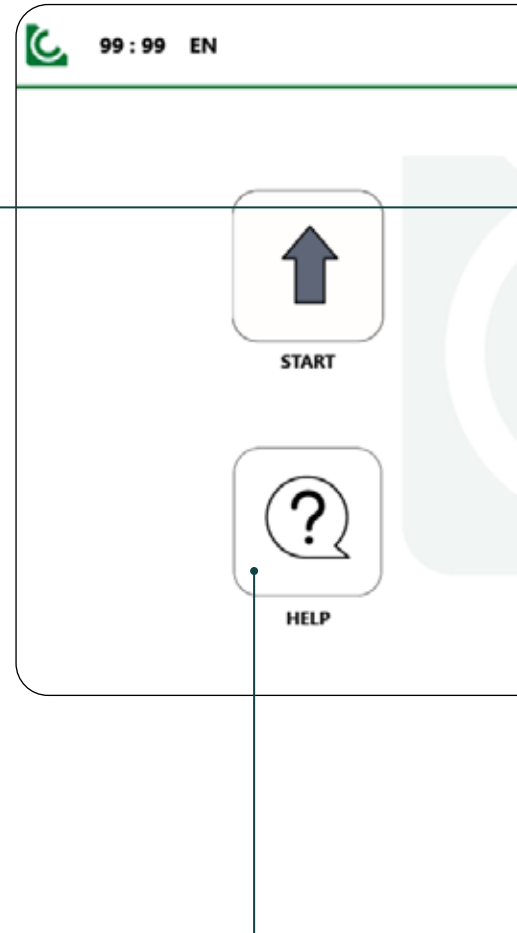
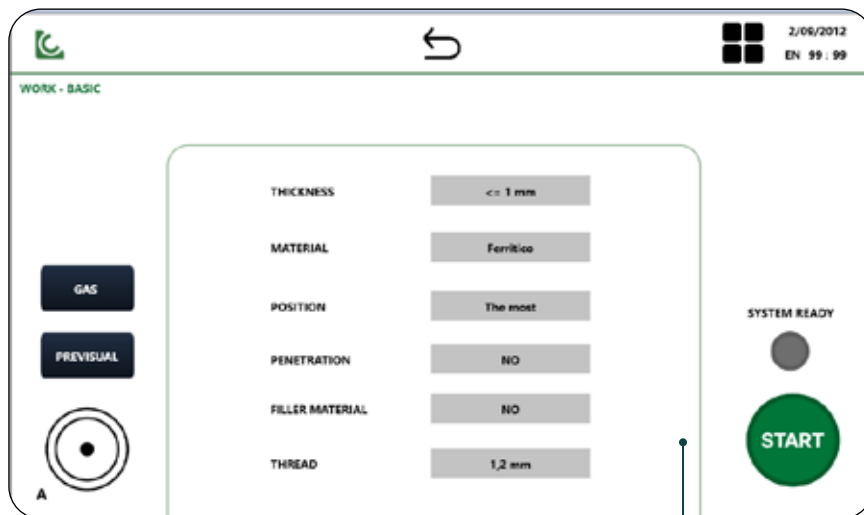

Welding screen

EPIS reminder, laser status indicators and feeder control.

Indicator light when the laser is operating.

Synergistic parameters



Integrated software designed and programmed by LC. Intuitive and easy to use, with different functionalities. Software that allows remote technical assistance, different work modes, job scheduling and user control at different levels.

Depending on the user's permissions, the operator will have access to some functionalities or others.

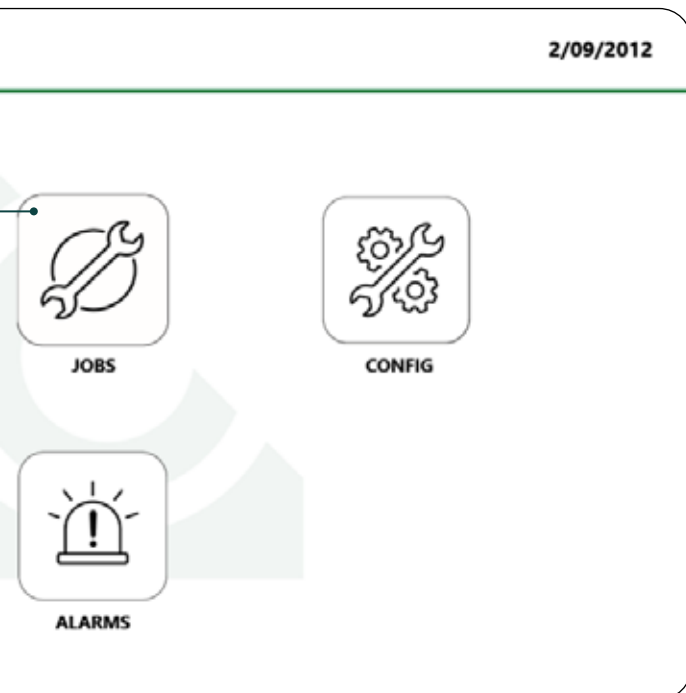

Unlike LC-WELD PRO...

The LC-WELD SMART software does not include:

- 4.0 Technology
- Different user levels and user control.
- Cost control and statistics.
- Access to videos within the software.
- Work based on Jobs or tasks.

Video and documentation on the same equipment

Direct access on the same computer to:

- Videos for questions and doubts
- Documentation (manual, CE, warranty)



Feeder

Winding machine designed to work at low speeds, improved laser welding performance.

Removable wire feeder without the need of an external system

Improved wire feed quality



Encoder motor made in Italy



Special sheaves for aluminum



Laser welding gun - LC-WELD GUN SM V 4.2

LC-WELD PRO presents a new gun with a renewed design and original.



New tube system

Easy introduction and collocation.
Pressure fastening and subsequent thread.
Millimeter tube to find the focal length easily along with new help software.
*We have added innovative software to determine focal length uniformly across all clients.

Focal length improvement

The focal length does not change with the change of nozzle.
New Software*

2 lens protectors, focal lens and collimator lens in easy-removal drawers

Easy maintenance and change of lenses

New S.M. technology

Directional mirror system replaces the galvanometric system.
Interior plans impossible.

Improves gear factor in aluminum (Between 2 and 3 times higher)

Incorporates laser cleaning option

Better ergonomics

Lower weight and more manageable system.

Driver included in the gun

Eliminates interference problems.

Change tool built-in lenses

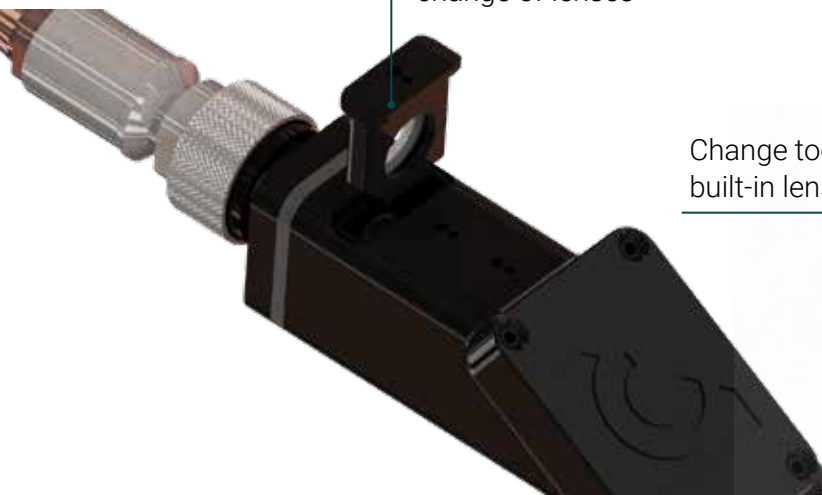

Materials and applications

Material tables

	WELDING
Stainless steel	✓
Galvanised steel	✓
Aluminium	✓
Titanium	✓
Carbon steel	✓
Special alloys	✓

1
Minimal deformation

2
Elimination of the reworking process

3
More penetration

Applications and Industry

Laser welding allows to reduce the affected thermal zone at the moment of working, being able to use different joining and welding techniques.

Laser welding machinery is highly versatile, especially due to its wide range of penetration and laser power. Different applications of laser welding equipment can be highlighted: electronics, automotive parts, veneering, metal furniture, some parts of household appliances, tubes and pipes, metal tools, containers for different industries, food industry (machinery, packaging or cutting blades), pharmaceutical industry, titanium and aluminium parts...

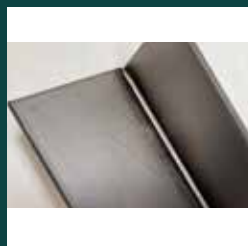
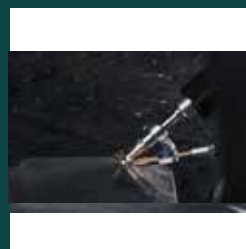

Laser security

LC has the necessary PPE to work with the LC-WELD PRO equipment.

Safety glasses

Mandatory for working with lasers, DLB 6 protection.

Note: Make sure your goggles provide protection for the laser beam and wavelength of your laser equipment. Consult an expert.



Welding mask

Necessary protection from UV light generated by the welding process.





Cabin

Adaptable according to the customer's needs, if necessary. LC-CABIN is a modular cabin to establish a controlled laser working area, in case the customer does not have one by his own means.



WE CARE ABOUT YOU.

Process comparison

	TIG	LASER
		
PENETRATION	1.0-1.5mm	up to 5mm
SPEED	slow welds	very fast welds
DISTORTION	lots of deformation	minimal deformation
SKILL	highly skilled welder	no great experience required

Joint configurations

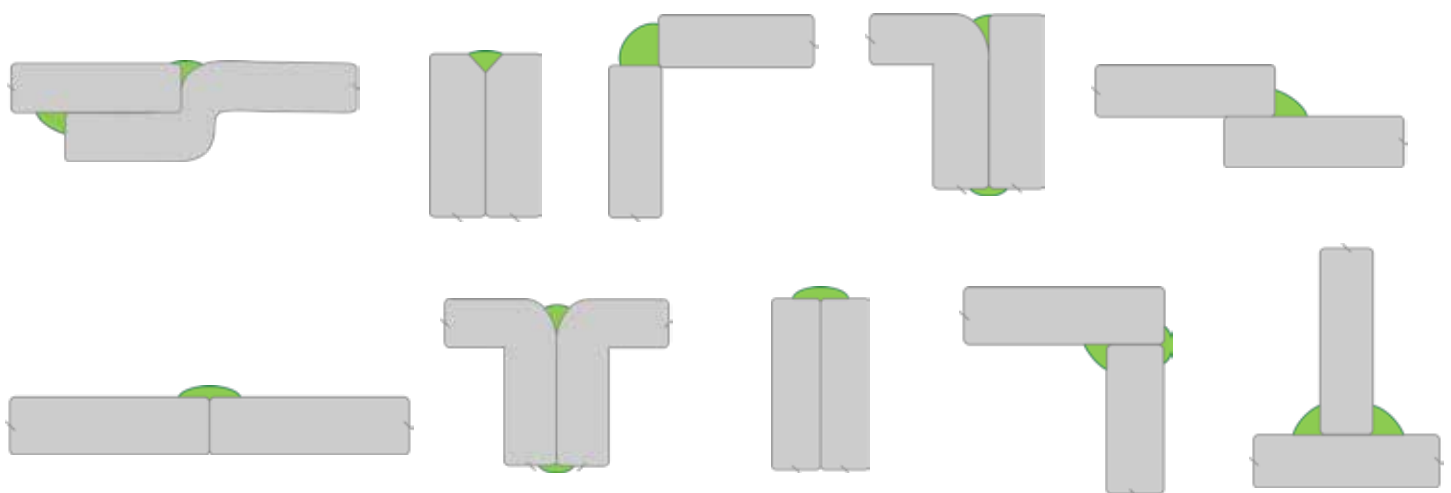

Technical information

Model	LC-WELD SMART
Laser power	1500w
Power consumption	<4200W
Power supply voltage	220-240VAC
Wavelength	1070nm ±10
Frequency range	<50 kHz
Power stability (2 hours)	<2%
Power stability (24 hours)	<3,5%
Laser efficiency	42%
Laser class	4 (IEC 60825-1)
Weight	< 80 kg
Hose length Approx.	8m
Approx. dimensions	875x447x865 mm

LC WELD SMART

VS

LC WELD PRO

1500W

7" screen

1500W

10" screen

SOFTWARE



4.0 Tech



User control



Cost control



Jobs



Video tutorials



LÁSER

>40%

Electric-optical conversion efficiency

>42%

500W

Electric-optical conversion efficiency

350W

EQUIPO



Bottle holder



Smaller

Dimensions

Larger size

<70kg

Weight

<120kg

Active Air Cooling

Water Cooling



C/ Pere Andorrà, 5, Nave 6
08650 · Sallent
Barcelona (Spain)

M. +34 623 337 600
T. +34 936 281 426

contacto@lclasers.com



www.lclasers.com

02.11.01_EN_001